

7.5" x 3"

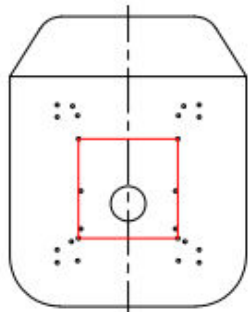

7.875" x 7.875"

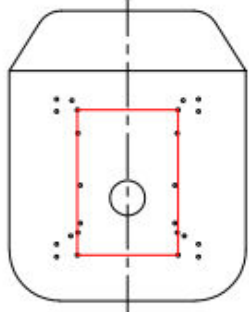

8" x 11.5"

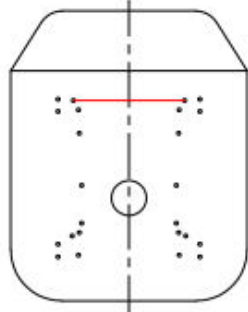

11.25" x 10.5"

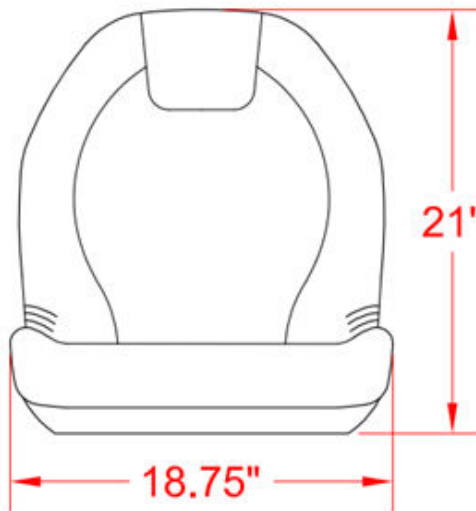

18.75"

21"

4.5"

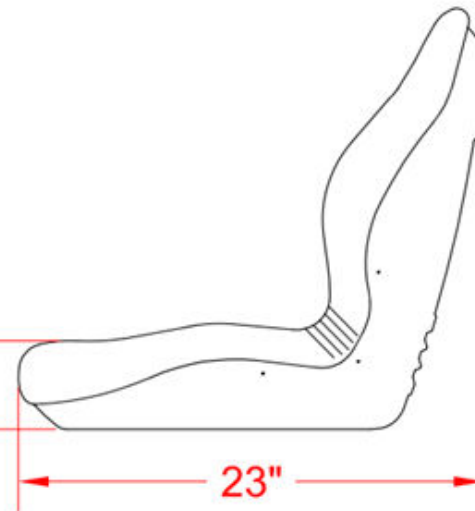

23"

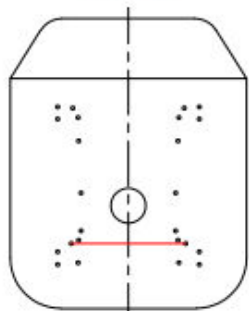

9.08" x

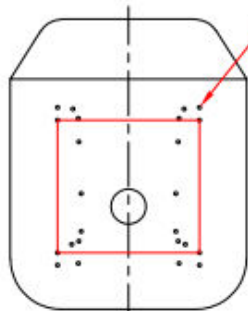

24) 5/16-18

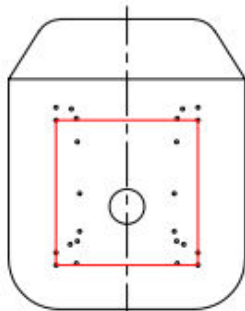

11.25" x 11.5"

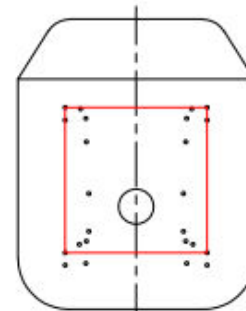

11.25" x 11.5"

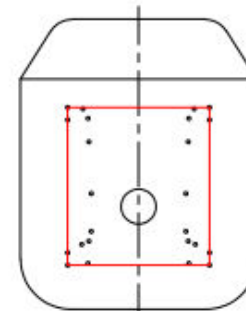

11.25" x 12.5"

E		
D		
C		
B		
A		
REV.	DATE	DESCRIPTION

**SEATS
UNLIMITED**

Part #: 149000	Units: Inch
Drawn By:	Scale: NTS