

7.5" x 3"

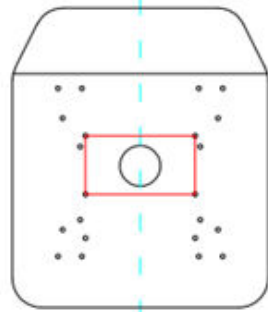

7.5" x 4"

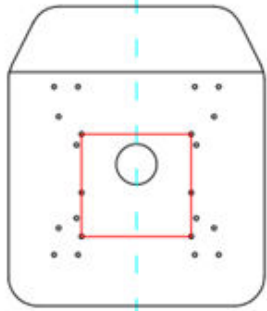

7.5" x 7"

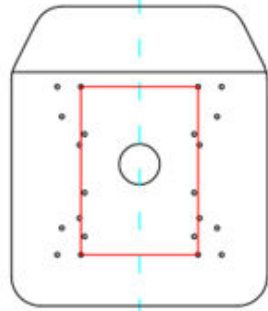

8" x 11.5"

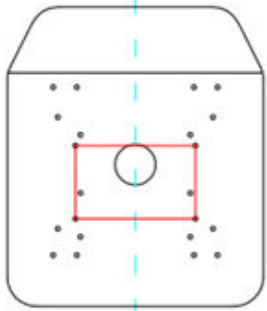

8.2" x 5"

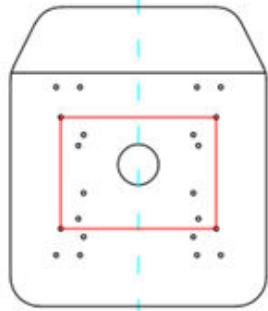

10.625" x 7.625"

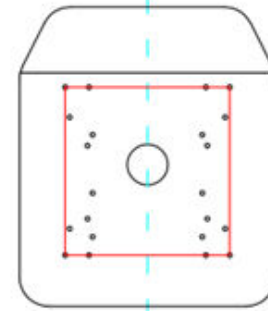
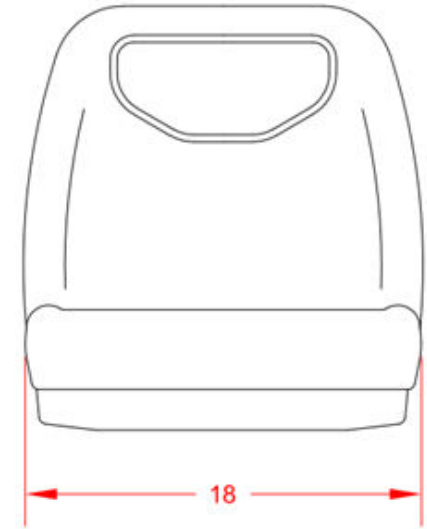
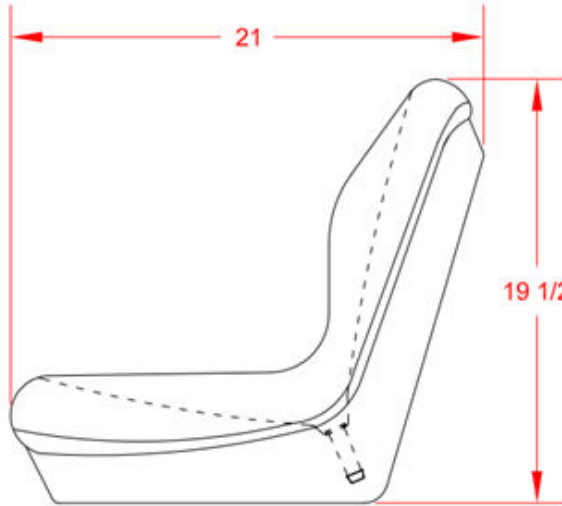

11.25" x 11.5"

E		
D		
C		
B		
A		
REV.	DATE	DESCRIPTION

**SEATS
UNLIMITED**

Part #: 140010	Units: Inch
Drawn By:	Scale: NTS